

BACK THRU AND AROUND THREE MARKERS

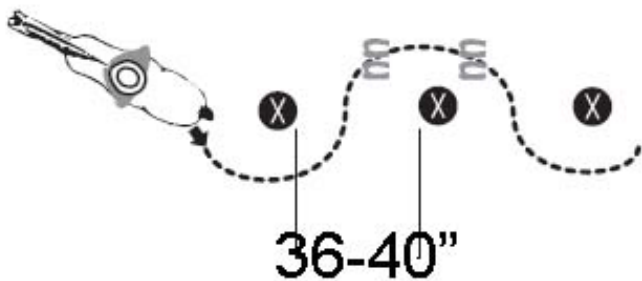

BACK THRU AND AROUND THREE MARKERS

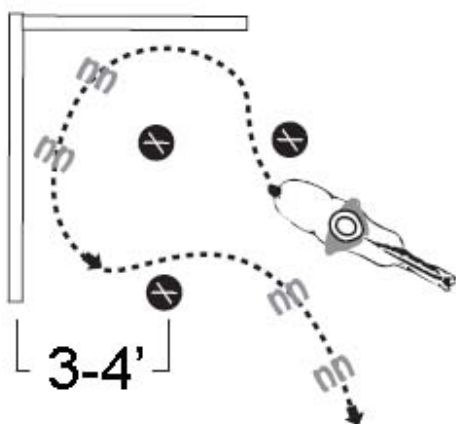
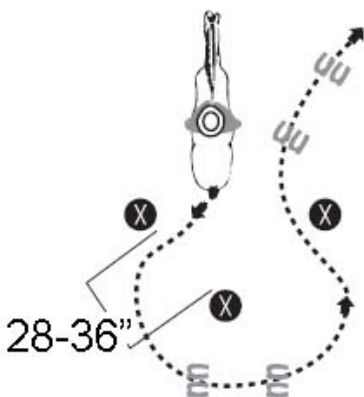
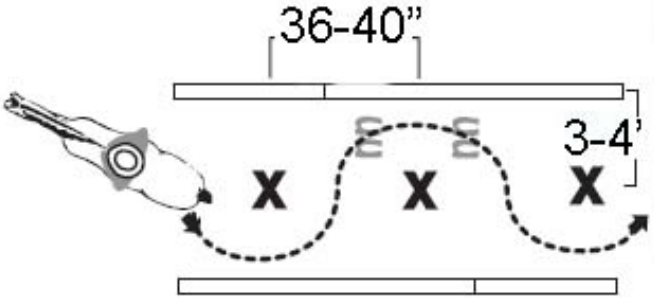

TROT OVERS, LOPE OVERS

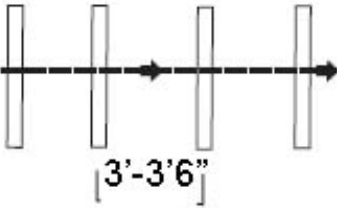

Trot Over Poles

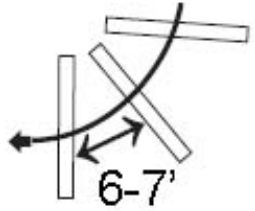

Lope Over Poles

WALK OVERS

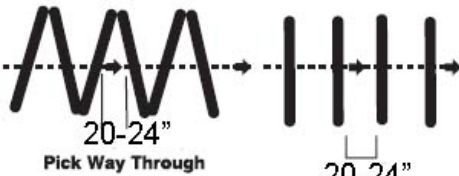

Pick Way Through



Curved

VARIATIONS OF SIDEPASS

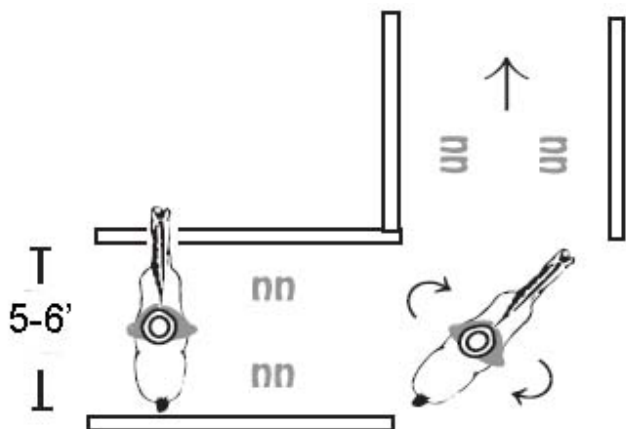

SIDEPASS RIGHT, TURN RIGHT
SIDEPASS LEFT

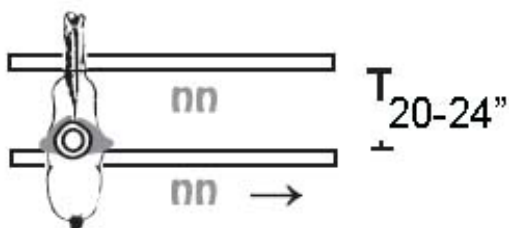

FRONT FEET INSIDE OR
BACK FEET INSIDE

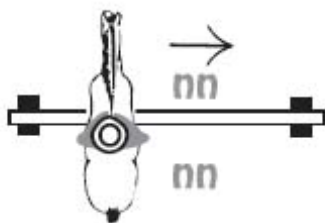

RAISED OBJECT
no more than 12"

VARIATIONS OF SIDEPASS

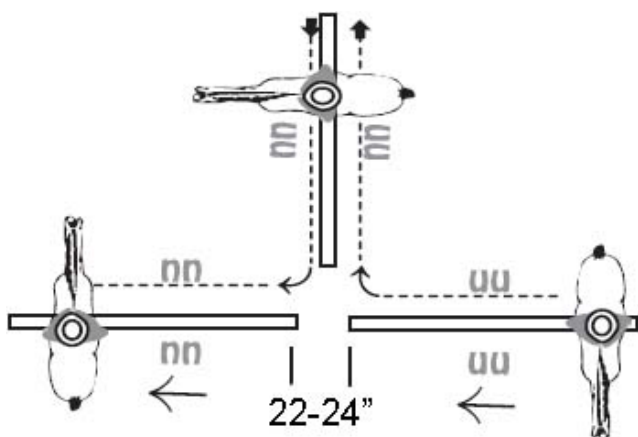

VARIATIONS OF L BACK THROUGH

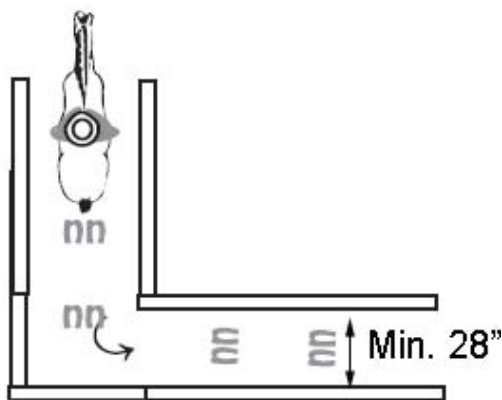
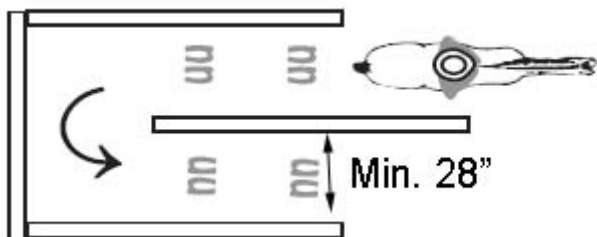

TROT OVER, LOPE OVERS & WALK OVERS

**Can use
Walk Overs, Trot Overs
& Lope Overs in One Class**

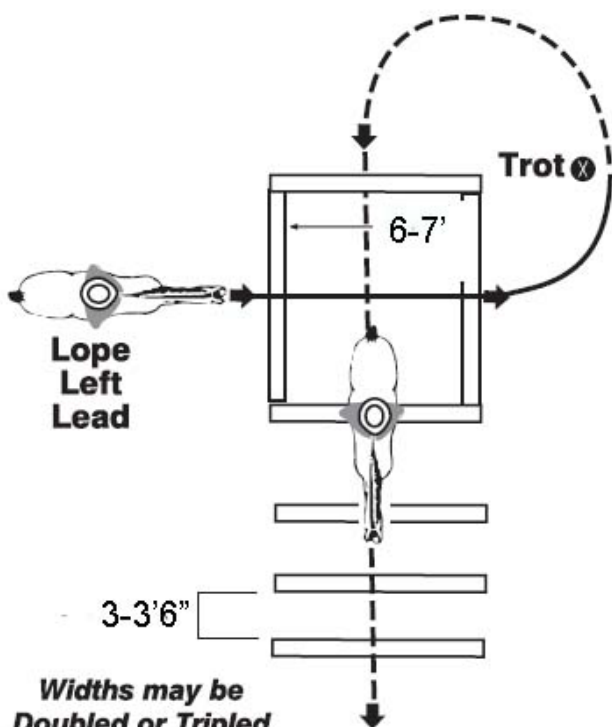

***Widths may be
Doubled or Tripled
to allow for more
than one stride
between poles.***