

# 1994 Land Values by Crop Reporting District

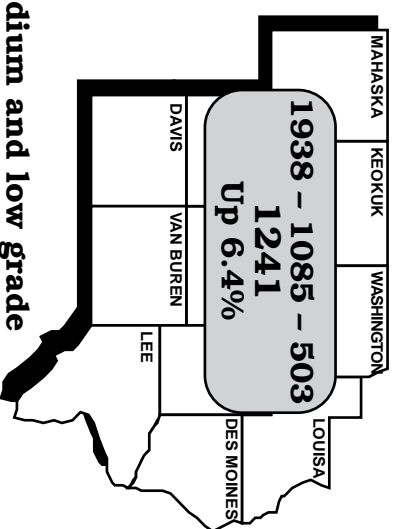
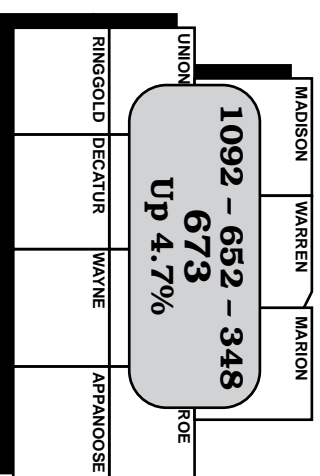
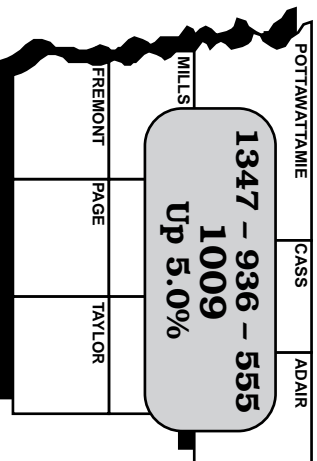
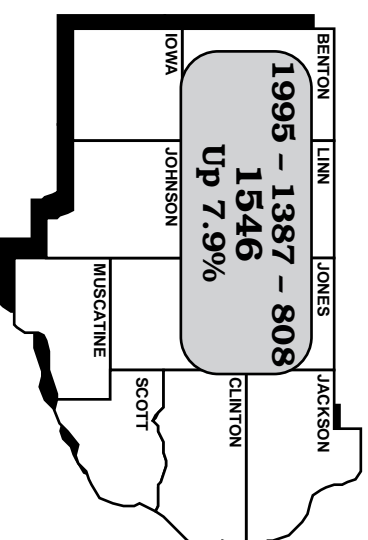
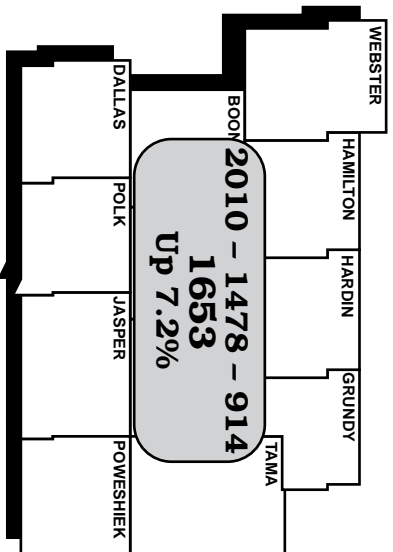
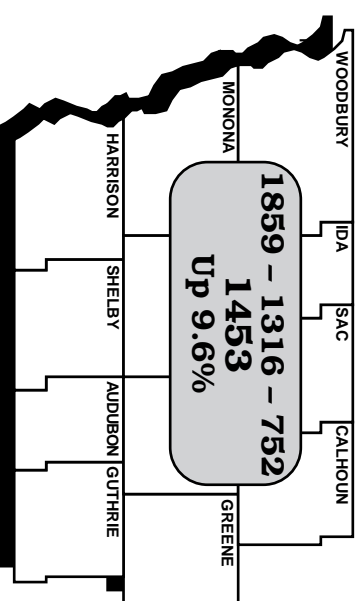
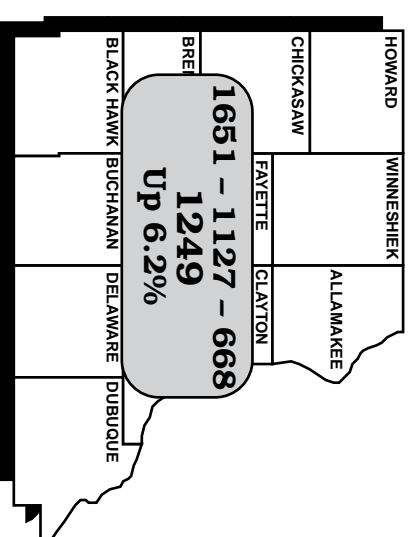
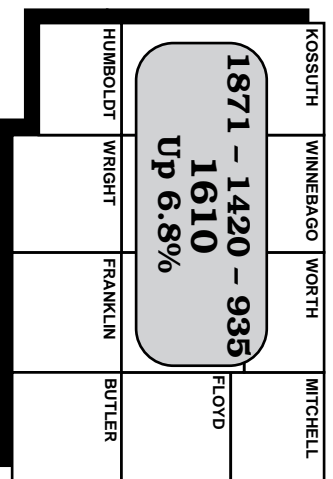
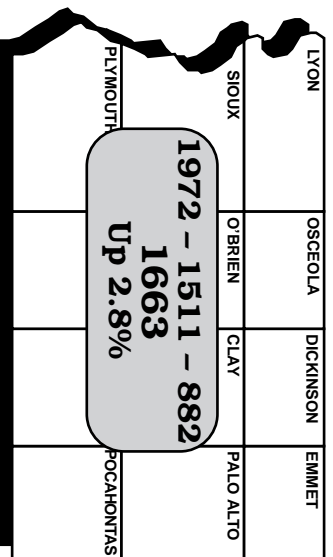

Estimates of average dollar value per acre for high, medium and low grade farmland on Nov. 1, 1994, by Iowa Crop Reporting District; and the Crop Reporting District average and the average percentage change from Nov. 1, 1993. The estimates are based on a survey of Iowa real estate brokers.

IOWA STATE UNIVERSITY

University Extension